

KOMATSU®

D39EXi-24 D39PXi-24

Tier 4 Final Engine

CRAWLER DOZER

D39i



intelligent | 2.0
MACHINE CONTROL

Photo may include optional equipment.

NET HORSEPOWER

105 HP @ 2200 rpm
78 kW @ 2200 rpm

OPERATING WEIGHT

D39EXi-24: 22,068 lb 10010 kg
D39PXi-24: 22,950 lb 10410 kg

BLADE CAPACITY

2.89–3.14 yd³
2.21–2.40 m³

WALK-AROUND

Next-generation intelligence

Enhanced machine efficiency for work ranging from heavy dozing to finish grading with intelligent Machine Control technologies.

Lift layer control

Achieves consistent lift layers with automatic control.

Quick surface creation

Creates a temporary design surface with the press of a button.

Proactive dozing control

Cut and carry work performed with the smoothness of an experienced operator.

Tilt steering control

Reduces need for constant operator corrections toward target point.

Two antennas to support multiple global navigation satellite system (GNSS)

Improved satellite signal stability and reception offer more reliability and accuracy.

Factory installed information and communication technology (ICT) system standard

Improved reliability and durability.



Photo may include optional equipment.

NET HORSEPOWER

105 HP @ 2200 rpm
78 kW @ 2200 rpm

OPERATING WEIGHT

D39EXi-24: 22,068 lb 10010 kg
D39PXi-24: 22,950 lb 10410 kg

BLADE CAPACITY

2.89–3.14 yd³
2.21–2.40 m³

D39EXi/PXi-24



INNOVATIVE. INTEGRATED. INTELLIGENT.

Standard intelligent Machine Control 2.0
Standard factory-installed integrated 3D
GNSS intelligent machine control system.

Improved Machine Control
Up to 8% more efficient dozer operation
than comparable aftermarket machine
control systems in start to finish
grading tests.

Factory Installed Machine Control Components

Machine control components are factory installed and designed as an integral part of the base machine for improved durability.

Komatsu Quality

Machine control components and system validated to Komatsu's rigorous quality & durability standards.

Industry Standard Compatibility

Machine control system makes use of common industry design data file norms and supports typical base station communication.

Simple Operator Interface

Simple touch screen control box with multi-color customizable display.

3D GNSS Machine Control (Standard)

All on-machine components are standard including control box, GNSS receiver/radio, GNSS antenna, and enhanced inertial measuring unit sensor.

Finish Grade Performance

Enhanced sensor package and intelligent logic provides for finish grade accuracy in an integrated system without traditional blade mounted sensors.

Enhanced Inertial Measuring Unit (IMU+)

Chassis mounted enhanced inertial measuring unit (IMU+) and intelligent logic provides for finish grade accuracy without blade mounted sensors.

Dual Cab Top GNSS Antennas

Load control intelligence controls blade elevation to improve productivity and minimize track slip by adjusting blade load. 1.0' from grade or 0.1' from grade – you can run in auto mod..

Intelligent Dozing Mode Settings

Operators are able to select between 4 distinct machine control operating modes to optimize performance to the application whether cutting, spreading, or other.

Operator Selectable Load Settings

Machine control load settings can be adjusted between presets to tailor response to material conditions.

SAA4D95LE-7 variable flow turbocharged and aftercooled 3.26 liter diesel engine provides excellent fuel economy. This engine is EPA Tier 4 Final emissions certified.

Variable Flow Turbocharger uses a simple valve to provide optimum air flow under all speed and load conditions.

Komatsu Diesel Oxidation Catalyst (KDOC) and Selective Catalytic Reduction (SCR) systems reduce particulate matter and NOx using passive regeneration 100% of the time. No active or manual regeneration is required.

New Komatsu Auto Idle Shutdown helps reduce excessive idle time.



Photo may include optional equipment.

Efficient Cooling System:

- Electronically controlled, hydraulically-driven fan is manually reversible
- Radiator cover with gas assisted lift cylinders, opens easily for cleaning
- Side-by-side coolers with increased cooling capacity

Integrated ROPS cab features:

- Large, quiet, and pressurized cab
- Excellent visibility with integrated ROPS structure
- Heated air-ride seat with high capacity suspension (standard)
- Standard aux jack and (2) 12V power converters
- Bluetooth radio and LED worklights

Self-adjusting idler support provides constant and even idler tension, reducing vibration and increasing undercarriage life.

Parallel Link Undercarriage System (PLUS) provides up to double the wear life and lowers repair and maintenance costs.

New Triple Labyrinth Final Drive provides additional protection for the final drive floating seals.

Power Angle Tilt (PAT) dozer with manually adjustable blade pitch increases productivity in a variety of applications.

Complete operator blade control:

- Palm Command Control System (PCCS)
- Electronic Proportional Control (EPC)
- Adjustable Quick shift and Variable shift modes
- Blade angle switch
- New three blade control settings
- Multiple Operator memory storage

Efficient Hydrostatic Transmission with electronic control:

- Customizable quick shift (3 speed) settings for the operator
- Variable speed selection (20 speeds)
- Low speed matching technology (larger displacement pumps/efficient engine speed)
- HST control system can reduce fuel consumption

INTELLIGENT MACHINE CONTROL

D39EXI/PXI-24



Photo may include optional equipment.

intelligent Machine Control (iMC) 2.0

D39EXI/PXI-24 utilizes intelligent Machine Control 2.0 a GNSS* system that automatically controls the blade to 3-dimensional design data. Machine Control 2.0 utilizes the industry's first Proactive Dozing Control logic, lift layer control, quick surface creation, and tilt steering control. A two-antenna system supporting multiple GNSS, which provides less downtime and more work time. These added features make for improved production and efficiency.

*GNSS (Global Navigation Satellite System): General term for satellite positioning systems such as GPS, GLONASS, etc.

Quick surface creation

Operators can create a temporary design surface with the press of a button. Designed to simplify in-field surface creation within the control box, it allows for more utilization of iMC 2.0.



Tilt steering control

The blade automatically tilts under a heavy load to maintain a straight line of travel, optimizing productivity throughout each pass and reducing operator fatigue.



Auto/manual switch

A conveniently located on/off switch giving the operator control of when iMC 2.0 is active.



Function switches

Cut/fill offset switch

The target surface height can be quickly adjusted by pressing the offset switch (button).

Back grade mode switch

Allows for automatic control during back grading.

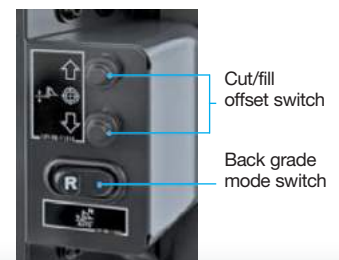

Lift layer control

Optimize earthwork productivity and maintain compaction quality by automatically controlling lifts to the desired heights with respect to the mapped terrain. Excess fill is eliminated as automatic blade control will follow finish surface once lifts have reached finish grade.

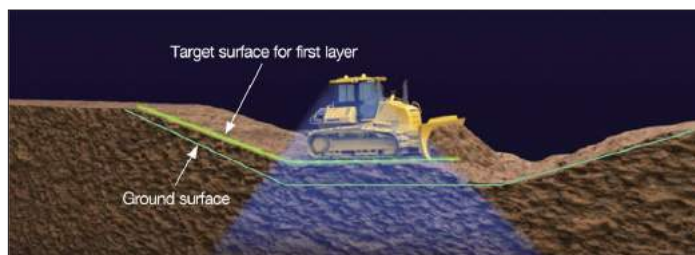

Proactive dozing control

Operators can utilize automatic blade control from rough grading to finish grading work. Proactive dozing control understands the terrain in the path of each cut, maximizes the blade load throughout the pass, regardless of the terrain ahead, and achieves productivity similar to that of an experienced operator.

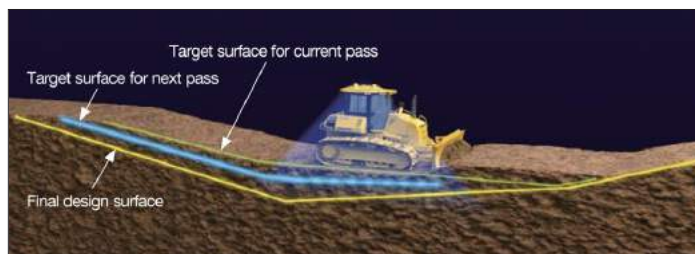

Two antennas supporting multiple GNSS

Work accuracy is improved by two antennas supporting the multiple GNSS.

Improvement of blade accuracy on slope

Blade accuracy is maintained during slope work.



Reliability of blade accuracy

Galileo, QZSS, and BeiDou can be used in addition to GPS and GLONASS. Since the satellite capture rate is improved, the machine can be used in any time zone.



Control box

- 1 L.H. LED indicator 2 Upper LED indicator
- 3 R.H. LED indicator
- 4 Power ON/OFF and menu switch (Press: Display the main menu / Hold down: Turn ON/OFF the power supply)
- 5 Zoom in switch 6 Zoom out switch
- 7 Toggle main view switch (Press: Switch the display of main window / Hold down: Adjust the brightness and sound volume)
- 8 Left window 9 Main window 10 Lower window
- 11 Right window 12 Speed control ON/OFF
- 13 Take a topo shot 14 Simple grading ON/OFF
- 15 Cut depth selection 16 Smooth start ON/OFF
- 17 Tilt steering ON/OFF 18 Toggle As-built mode change view to [none], [cut fill], [pass counts]
- 19 Quick surface creation (Create slope plane surface)
- 20 Lift layer control (Create As-built design surface)
- 21 Elevation control key 22 Slope control key
- 23 GNSS status 24 Radio status 25 Cut/Fill offset
- 26 Cut/Fill reading 27 Tilt of blade
- 28 Design cross-slope 29 Type of control
- 30 AUTO indicator 31 Back Grade mode indicator
- 32 Lift indicator

*This is a typical main screen of control box.

PERFORMANCE FEATURES

KOMATSU NEW ENGINE TECHNOLOGIES

Komatsu's New Emission Regulations-compliant Engine

New regulations effective in 2014 require the reduction of NOx emissions. In addition to refining the U.S. EPA Tier 4 Interim technologies, Komatsu developed a new Selective Catalytic Reduction (SCR) device in-house.

- ① Komatsu Diesel Oxidation Catalyst (KDOC)
- ② Variable flow turbocharger
- ③ Komatsu Closed Crankcase Ventilation (KCCV)
- ④ SCR

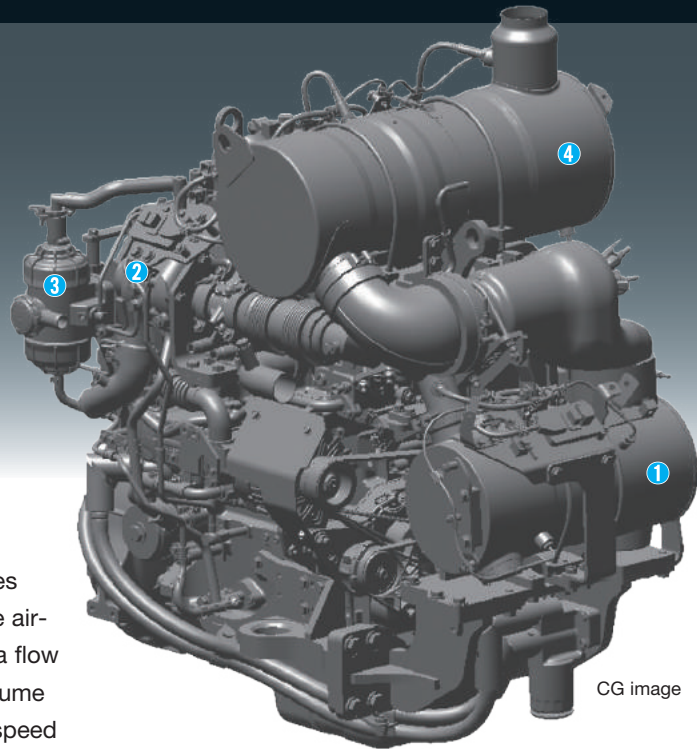

CG image

Technologies Applied to New Engine

Water cooled variable flow turbocharger

A newly designed variable flow turbocharger features simple and reliable technology that varies the intake air-flow. Exhaust turbine wheel speed is controlled by a flow control valve that enables delivery of an optimal volume of air to the engine combustion chamber under all speed and load conditions. The result is cleaner exhaust gas while maintaining power and performance.

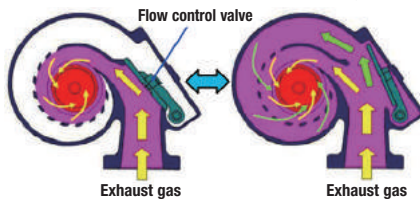

Heavy-duty aftertreatment system

This new system consists of a KDOC and a SCR. The SCR NOx reduction system injects the correct amount of Diesel Exhaust Fluid (DEF) at the proper rate, thereby decomposing NOx into non-toxic water (H₂O) and nitrogen gas (N₂).

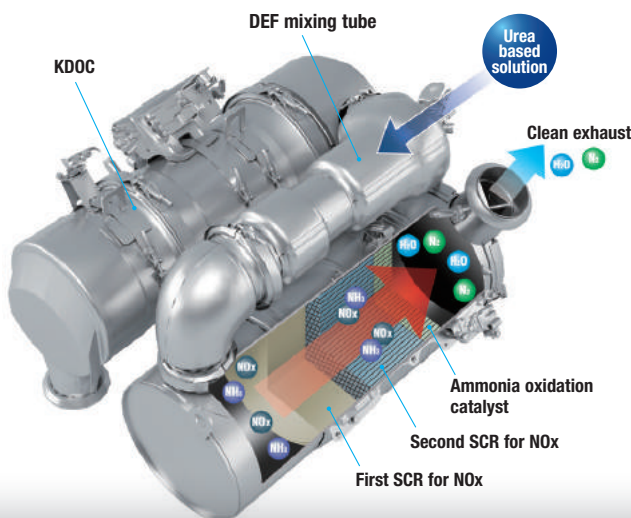

Cooled Exhaust Gas Recirculation (EGR)

Cooled EGR, a technology well-proven in existing Komatsu engines, reduces NOx emissions. These components ensure reliable performance during the demanding work conditions of construction equipment.

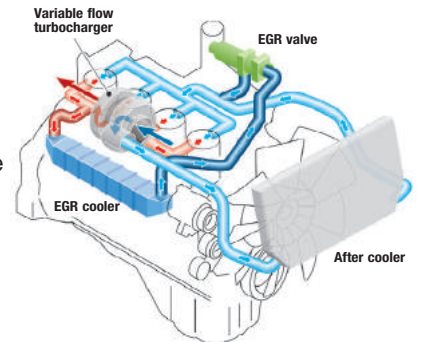

Komatsu Closed Crankcase Ventilation (KCCV)

Crankcase emissions (Blowby gas) are passed through a KCCV filter. The KCCV filter traps oil mist which is returned back to the crankcase while the gas, which is almost oil mist free, is fed back to the air intake.



Heavy-duty High Pressure Common Rail (HPCR) fuel injection system

The system is designed to achieve an optimal injection of high-pressure fuel by means of computerized control, thereby bringing close to complete combustion to reduce Particulate Matter (PM) emissions. While this technology is already used in current engines, the new system uses higher-pressure fuel injection, thereby reducing both PM emissions and fuel consumption over the entire engine power range.

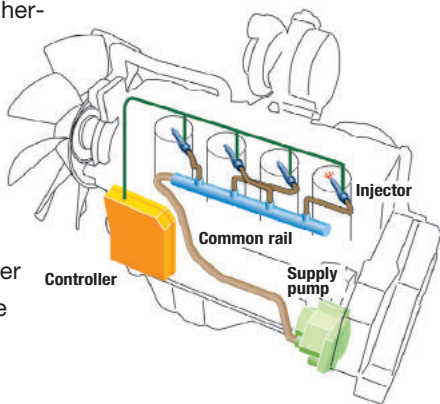

Advanced electronic control system

The electronic control system performs high-speed processing of all signals from sensors installed in the vehicle and engine. This ensures total control of the equipment under all conditions. Engine condition information is displayed via an on-board network on the monitor inside the cab. Furthermore, KOMTRAX helps customers use this information to keep up with maintenance needs.

Redesigned combustion chamber at top of piston

The combustion chamber at the top of the piston has a new shape designed to improve combustion and further reduce NOx, PM, fuel consumption and noise.

Auto Idle Shutdown Function

Komatsu auto idle shutdown automatically shuts the engine down after idling for a set period of time to reduce unnecessary fuel consumption and exhaust emissions. The amount of time before the engine is shutdown can be easily programmed from 5 to 60 minutes.



Photo may include optional equipment.

PRODUCTIVITY & FUEL ECONOMY FEATURES

HYDROSTATIC TRANSMISSION (HST) CONTROL SYSTEM

HST Control System

The HST controller monitors engine output and work load. It controls HST pump and motor displacement to provide the optimum speed and drawbar pull. Full power to both tracks during turns or counter-rotation makes the D39EXi/PXi-24 extremely maneuverable.



Fuel Efficiency

The efficient HST control system can reduce fuel consumption.

Fuel consumption reduced by up to 5%

Compared with D39EXi/PXi-23 in P mode
Based on typical work pattern collected via KOMTRAX

Hydraulically Driven Cooling Fan

The engine cooling fan's speed is electronically controlled. Fan speed depends on engine coolant and oil temperatures. The fan will only rotate as fast as is necessary to adequately cool the machine's fluid. This system increases fuel efficiency, reduces operating noise levels and requires less horsepower than a belt-driven fan.

Selectable Working Mode

P mode is the mode designed for powerful operation and maximum production. E mode is designed for general dozing applications, providing adequate speed and power, while saving energy. For fuel reduction and energy savings, the monitor panel allows the operator to easily switch between working modes, depending on working conditions.

P mode (Power mode)

With P mode, the engine outputs its full power, allowing the machine to perform work requiring large production, heavy-load, and uphill work.

E mode (Economy mode)

With E mode, the engine outputs enough power for the work without delivering unnecessary power. This mode enables energy saving operation and is ideal on hard or rough surfaces that often cause shoe slip and work not requiring as much power, such as downhill dozing, leveling and light-load work.

PAT DOZER

PAT Dozer with Adjustable Pitch

A power angle power tilt dozer blade with adjustable blade pitch system is available on the D39EXi/PXi-24. The hydraulic blade tilt and angling function expands versatility and productivity in a variety of applications and manually adjustable blade pitch.

**Unrivalled Blade Visibility**

The D39EXi/PXi-24 incorporates Komatsu's super-slant nose design. Komatsu's innovative design provides excellent blade visibility for improved machine control and increased efficiency and productivity.



Photo may include optional equipment.

CONTROL FEATURES



Palm Command Control System (PCCS) Levers

Komatsu's ergonomically designed PCCS handles create an operating environment with complete operator control.

PCCS

The low-effort PCCS joystick controls all directional movements, including machine travel speed as well as counter-rotation.

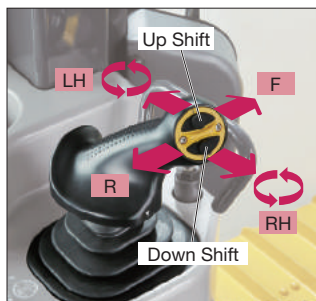

Electronic controlled hydraulic system

Electronic controlled palm commanded joystick provides precise blade control. New blade angling switch operation provides easier and predictable blade control.



HST with Electronic Control

The D39EXi/PXi-24 is equipped with Komatsu-designed HST that allows for Quick-Shift or variable speed selection. The HST consists of dual-path closed-circuits, with two variable displacement piston pumps and two variable displacement travel motors. Hydrostatic steering eliminates steering clutches and brakes, providing smooth, powerful turns. Fully electronic control provides complete automatic shifting and enables smooth control. Engine speed is controlled using an electronic fuel control dial.

One-Pedal Design (Decelerator/Brake Pedal) Controls Speed, During Operation

Machine operation is simple because brake function has been integrated into the decelerator pedal. Machine travel speed can be controlled using one pedal. The pedal function can be changed by a mode selector switch.

Decelerator mode: The pedal modulates engine rpms and vehicle travel speed. It can be used for all applications.
Brake mode: The pedal modulates vehicle travel speed while maintaining high-engine speed. This mode can be helpful to maintain work-equipment speed, while using the brake function.



WORKING ENVIRONMENT



Integrated ROPS (ISO 3471) Cab

The D39EXi/PXi-24 has an integrated ROPS (ISO 3471) cab with Bluetooth radio and LED worklights. High rigidity and superb sealing performance sharply reduce noise and vibration for the operator and discourage dust from entering the cab. In addition, side visibility is increased because external ROPS (ISO 3471) structure and posts are not required.



Comfortable Ride with Heated Operator Seat

The operator seat has adjustable lumbar support, tilt and an electric heater. It is easy to adjust to the operator's shape and comfortable operation is possible in a variety of conditions. Also, the seat heat makes it possible to work comfortably in the winter.



Comfortable Ride with Cab Damper Mounting

The D39EXi/PXi-24's cab mount uses a cab damper system that provides excellent shock and vibration absorption which conventional mounting systems are unable to match. The silicon-oil-filled cab damper mount helps to isolate the cab from the machine body, suppressing vibration and providing a quiet, comfortable operating environment.

Auxiliary Input Jack & Two DC12 Volt Electrical Outlets

By connecting an auxiliary device to this plug input, the operator can play audio from a mobile device through the machine's sound system. Two DC12 volt electrical outlets can be used as a power source for radio equipment or others.

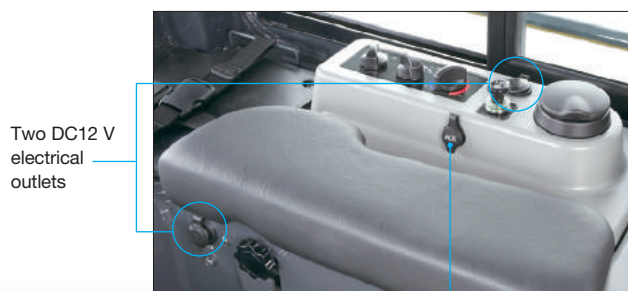

Auxiliary input jack

ADDITIONAL OPERATOR CONVENIENCE EQUIPMENT

Rear view monitor system

On the large LCD color monitor, the operator can view, through one camera, areas directly behind the machine. This camera can be synchronized with reverse operation.



Secondary engine shutdown switch

A new secondary switch has been added at the side of the front console to shut down the engine.



RELIABILITY & MAINTENANCE FEATURES

Excellent Reliability & Durability

Parallel Link Undercarriage System (PLUS)

Komatsu's PLUS rotating bush design provides less downtime, longer wear, and with up to 40% lower undercarriage maintenance costs. Rotating bushings eliminate the cost and downtime for bushing turns, and strengthened rollers and links increase wear life up to two times. With PLUS, individual links can be replaced with common track tools.

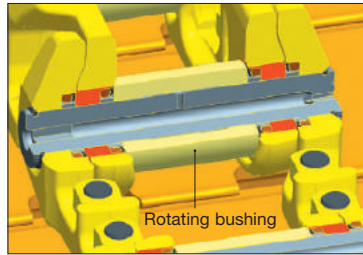

Modular design

One of the design goals behind the creation of the D39EXi/PXi-24 was to manufacture a more durable machine. This was achieved by reducing component complexity and using a strong modular design for increased serviceability and durability.



Self-adjusting idler support

The self-adjusting idler support provides constant and even tension on idler guide plates, reducing noise and vibration and increasing undercarriage life.

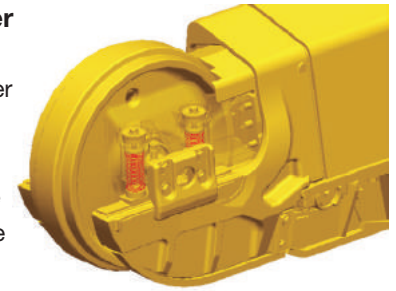

Easy Maintenance

Planned maintenance and daily checks are the only way to ensure long service life from equipment. That's why Komatsu designed the D39EXi/PXi-24 with conveniently located maintenance points to make necessary inspections and maintenance quick and easy.

Rear, hydraulically-driven, swing-up fan

The D39EXi/PXi-24 utilizes a swing-up fan with a gas strut-assisted lift system to provide easy access to the (side-by-side) radiator, oil cooler and charge air cooler. The hydraulic fan has a cleaning mode which enables the fan to rotate in the reverse direction to help clear off objects that are restricting air flow.



D39EX-24 Shown

TECHNOLOGY FEATURES



Large Multi-Lingual High Resolution LCD Monitor

A large, user-friendly color monitor provides easy-to-understand information for the operator. Excellent screen visibility is achieved with a high resolution LCD monitor that is easy to read at various angles and lighting conditions. Simple and easy-to-operate switches and function keys facilitate multi-function operations. The monitor displays data in 26 languages.



Multi-monitor with Troubleshooting Function to Minimize Down Time

Various meters, gauges and warning functions are centrally arranged on the multi-monitor. The monitor simplifies start-up inspection and promptly warns the operator with a lamp and buzzer if any abnormalities occur. In addition, warning indicators are displayed in 4 levels to alert the operator of potential issues. Replacement times for required PM services are also indicated.



Energy Saving Operation

Ecology guidance

In order to support efficient operation, the following four messages are displayed for fuel saving operation. These can be displayed by the operator, if desired.

- 1) Avoid Excessive Engine Idling
- 2) Use Economy Mode to Save Fuel
- 3) Avoid Hydraulic Relief Pressure
- 4) Avoid Over Load

Ecology gauge Ecology guidance



Fuel consumption display

Ecology gauge

To help the operator to perform in an environmentally friendly way and minimize energy consumption, an easy-to-read “Ecology gauge” is displayed on the left of the multi-monitor screen.

Fuel consumption display

Average fuel consumption during the day is displayed and updated every 10 seconds.

Ecological Operation Report for Assistance

KOMTRAX is Komatsu’s remote equipment and fleet monitoring system. Wireless technology and a secure web-based application offer the information needed to make the best possible operation and management decisions. From location, actual hours worked and fuel consumption, to maintenance monitoring, abnormality codes and load frequency, operators receive reports that are simple to read and understand. The new D39EXi/PXi-24 adds the following new information for fuel consumption reduction.

- Guidance to improve fuel consumption
- Ecological operation report.
- Operating hours by operation mode (E or P mode)
- Service information for U.S. EPA Tier 4 Final (regeneration information)

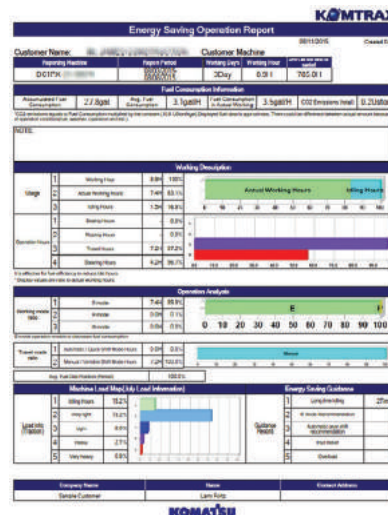

KOMATSU PARTS & SERVICE SUPPORT



KOMATSU CARE®

Program Includes:

*The D39EXi/PXi-24 comes standard with complimentary factory scheduled maintenance for the first 3 years or 2,000 hours, whichever occurs first.

Planned Maintenance Intervals at:

500/1000/1500/2000 hour intervals. (250 hr. initial interval for some products) Complimentary Maintenance Interval includes: Replacement of Oils & Fluid Filters with genuine Komatsu Parts, 50-Point inspection, Komatsu Oil & Wear Analysis Sampling (KOWA) / Travel & Mileage (distance set by distributor; additional charges may apply).

Benefits of Using Komatsu CARE

- Assurance of Proper Maintenance with OEM Parts & Service
- Increased Uptime & Efficiency
- Factory Certified Technicians Performing Work
- Cost of Ownership Savings
- Transferable Upon Resale

Complimentary SCR System Maintenance

The D39EXi/PXi-24 also includes 2 factory suggested services of the Selective Catalytic Reduction (SCR) Diesel exhaust fluid (DEF) system during the first 5 years or 9,000 hours, whichever occurs first:

- Factory suggested DEF tank flush and strainer cleaning at 4,500 hours and 9,000 hours

KOMATSU CARE D39EXi/PXi-24

Interval PM	500	1000	1500	2000
KOWA SAMPLING – (Engine, Hydraulics, L & R Final Drives)	✓	✓	✓	✓
LUBRICATE MACHINE	✓	✓	✓	✓
CHANGE ENGINE OIL	✓	✓	✓	✓
REPLACE ENGINE OIL FILTER	✓	✓	✓	✓
REPLACE FUEL PRE-FILTER	✓	✓	✓	✓
REPLACE A/C FRESH & RECIRCULATION FILTERS	✓	✓	✓	✓
DRAIN SEDIMENT FROM FUEL TANK	✓	✓	✓	✓
CLEAN AIR CLEANER ELEMENT	✓	✓	✓	✓
COMPLETE 50 POINT INSPECTION FORM; LEAVE PINK COPY WITH CUSTOMER OR IN CAB	✓	✓	✓	✓
RESET MONITOR PANEL MAINTENANCE COUNTER FOR APPROPRIATE ITEMS	✓	✓	✓	✓
REPLACE FUEL MAIN FILTER		✓		✓
REPLACE FUEL TANK BREATHER ELEMENT		✓		✓
REPLACE HYDRAULIC TANK BREATHER ELEMENT		✓		✓
REPLACE DEF TANK BREATHER ELEMENT		✓		✓
CHANGE FINAL DRIVE OIL		✓		✓
CHANGE HYDRAULIC OIL				✓
REPLACE HYDRAULIC FILTER				✓
REPLACE HST FILTER				✓
REPLACE KCCV FILTER				✓
REPLACE DEF PUMP FILTER				✓
CLEAN HYDRAULIC TANK STRAINER				✓
FACTORY TRAINED TECHNICIAN LABOR	✓	✓	✓	✓
2 SCR System Maintenance Services suggested at 4,500 Hrs. and 9,000 Hrs.				

Komatsu CARE® – Advantage Extended Coverage

- Extended Coverage can provide peace of mind by protecting customers from unplanned expenses that effect cash flow
- Purchasing extended coverage locks-in the cost of covered parts and labor for the coverage period and helps turn these into fixed costs



Komatsu Parts Support

- 24/7/365 to fulfill your parts needs
- 9 parts Distribution Centers strategically located across the U.S. and Canada
- Distributor network of more than 300 locations across U.S. and Canada to serve you
- Online part ordering through Komatsu eParts
- Remanufactured components with same-as-new warranties at a significant cost reduction



Komatsu Oil and Wear Analysis (KOWA)

- KOWA detects fuel dilution, coolant leaks, and measures wear metals
- Proactively maintain your equipment
- Maximize availability and performance
- Can identify potential problems before they lead to major repairs
- Reduce life cycle cost by extending component life

* Certain exclusions and limitations apply. Refer to the customer certificate for complete program details and eligibility. Komatsu® and Komatsu Care® are registered trademarks of Komatsu Ltd. Copyright 2019 Komatsu America Corp.

D39EXi/PXi-24

KOMTRAX EQUIPMENT MONITORING

intelligent / 2.0
MACHINE CONTROL

GET THE WHOLE STORY WITH
KOMTRAX[®]

✓ WHAT

- KOMTRAX is Komatsu's remote equipment monitoring and management system
- KOMTRAX **continuously monitors and records** machine health and operational data
- Information such as fuel consumption, utilization, and a detailed history **lowering owning and operating cost**
- KOMTRAX is **standard** equipment on all Komatsu construction products

✓ WHEN

- Know when your machines are **running or idling** and make decisions that will improve your fleet utilization
- Detailed movement records ensure you know when and where your equipment is moved
- Up to date records allow you to **know when maintenance is due** and help you plan for future maintenance needs

✓ WHERE

- KOMTRAX data **can be accessed virtually anywhere** through your computer, the web or your smart phone
- Automatic alerts keep fleet managers up to date on the latest machine notifications

✓ WHY

- Knowledge is power - **make informed decisions** to manage your fleet better
- Knowing your idle time and fuel consumption will help maximize your machine efficiency
- **Take control of your equipment** - any time, anywhere

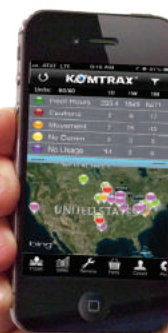

KOMTRAX[®]

For construction and compact equipment.

KOMTRAX Plus[®]

For production and mining class machines.

SPECIFICATIONS



ENGINE

Model..... Komatsu SAA4D95LE-7*
 Type4-cycle, watercooled, direct injection
 Aspiration..... Variable flow, turbocharged,
 air-to-air aftercooled
 Number of cylinders..... 4
 Bore x stroke..... 95 mm x 115 mm **3.75" x 4.52"**
 Piston displacement..... 3.26 ltr **199 in³**
 Governor..... All-speed, electronic
 Horsepower
 SAE J1995.....Gross 79 kW **107 HP**
 ISO 9249 / SAE J1349.....Net 78 kW **105 HP**
 Rated rpm.....2200 rpm
 Fan drive typeHydraulic
 Lubrication system
 Method.....Gear pump, force lubrication
 Filter..... Full-flow

*EPA Tier 4 Final emissions certified



HYDROSTATIC TRANSMISSION

Dual-path, hydrostatic transmission provides infinite speed changes up to 5.3 km/h **8.5 mph**. The variable capacity travel motors allow the operator to select the optimum speed to match specific jobs. Travel control lock lever and neutral switch.

Travel speed (quick shift mode)*	Forward	Reverse
1st	0-3.4 km/h 0-2.1 mph	0-4.1 km/h 0-2.5 mph
2nd	0-5.6 km/h 0-3.5 mph	0-6.5 km/h 0-4.0 mph

Travel speed (variable mode)	Forward	Reverse
	0-8.5 km/h 0-5.3 mph	0-8.5 km/h 0-5.3 mph

*Quick shift speeds are adjustable in the monitor.

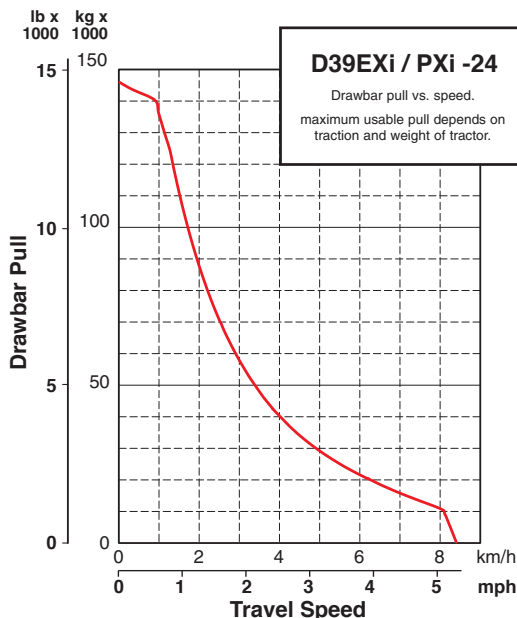

FINAL DRIVES

In-shoe mounted, axial-piston-type travel motors, with integrated two-stage planetary gear reduction. Compact in-shoe mount reduces risk of damage by debris. Bolt-on sprocket ring with triple labyrinth seal design.



STEERING SYSTEM

Palm Command Control System (PCCS) joystick control for all directional movements. Pushing the joystick forward results in forward machine travel, while pulling it rearward reverses the machine. Simply tilt the joystick to the left or right to make a turn. Tilting the joystick fully to the left or right activates counter-rotation.

Hydrostatic Transmission (HST) provides smooth powerful turns. Fully electronic control enables smooth control that can be adjusted in the monitor. The PCCS utilizes shift buttons to increase and decrease speed.

Minimum turning radius*

D39EXi-24..... 2.2 m **87"**

D39PXi-24..... 2.4 m **94"**

*As measured by track marks on the ground at pivot turn.



UNDERCARRIAGE

SuspensionRigid type
 Track roller frameMonocoque, large section, durable construction
 Rollers & idlersLubricated track rollers

Sealed & lubricated track...Track tension easily adjusted w/grease gun

	D39EXi-24	D39PXi-24 Narrow	D39PXi-24 Wide
Number of track rollers (each side)	6	7	7
Type of shoes (standard)	Single grouser	Single grouser	Single grouser
Number of shoes (each side)	39	39	39
Grouser height	mm in 47 1.9"	47 1.9"	47 1.9"
Shoe width (standard)	mm in 510 20"	635 25"	700 27.5"
Ground contact area	cm ² 23919	29782	32830
	in² 3,707	4,616	5,110
Ground pressure (with dozer, ROPS cab) (ISO 16754)	kPa 36.1	30.1	27.4
	kgf/cm ² 0.37	0.31	0.28
	psi 5.24	4.39	3.98
Track gauge	mm ft.in 1620 5'4"	1810 5'11"	1810 5'11"
Length of track on ground	mm ft.in 2345 7'8"	2345 7'8"	2345 7'8"



SERVICE REFILL CAPACITIES

Coolant	34 ltr	9.0 U.S. gal
Fuel tank	190 ltr	50.2 U.S. gal
Engine oil	11 ltr	2.9 U.S. gal
Hydraulic tank	64 ltr	17 U.S. gal
Final drive (each side).....	3.5 ltr	0.9 U.S. gal
Diesel Exhaust Fluid (DEF) tank	10 ltr	2.6 U.S. gal



OPERATING WEIGHT (APPROXIMATE)

Tractor weight:
Including ROPS cab, U frame for power angle tilt dozer, rated capacity of lubricant, coolant, full fuel tank, operator, and standard equipment.

D39EXi-24 8850 kg **19,510 lb**
D39PXi-24 9200 kg **20,282 lb**

Operating weight:
Including Power Angle Tilt dozer, ROPS cab, operator, standard equipment, rated capacity of lubricant, hydraulic control unit, coolant, and full fuel tank.

D39EXi-24 10010 kg **22,068 lb**
D39PXi-24 10410 kg **22,950 lb**



DIMENSIONS

	D39EXi-24	D39PXi-24
A	2710 mm 8'11"	3250 mm 10'8"
B	365 mm 1'2"	440 mm 1'5"
C	980 mm 3'3"	910 mm 3'
C'	1120 mm 3'8"	1105 mm 3'7"
D	820 mm 2'8"	820 mm 2'8"
E	440 mm 1'5"	440 mm 1'5"
F	2345 mm 7'8"	2345 mm 7'8"
G	4385 mm 14'5"	4385 mm 14'5"
H	3010 mm 9'11"	2850 mm 9'4"
I	47 mm 1.9"	47 mm 1.9"
J	1620 mm 5'4"	1810 mm 5'11"
K	460 mm 1'6"	635 mm 2'1"
L	2080 mm 6'10"	2445 mm 8'2"
M	2495 mm 8'2"	2990 mm 9'10"
N	4910 mm 16'1"	5020 mm 16'6"
O	2475 mm 8'1"	2940 mm 9'8"

Ground clearance 390 mm **15"**

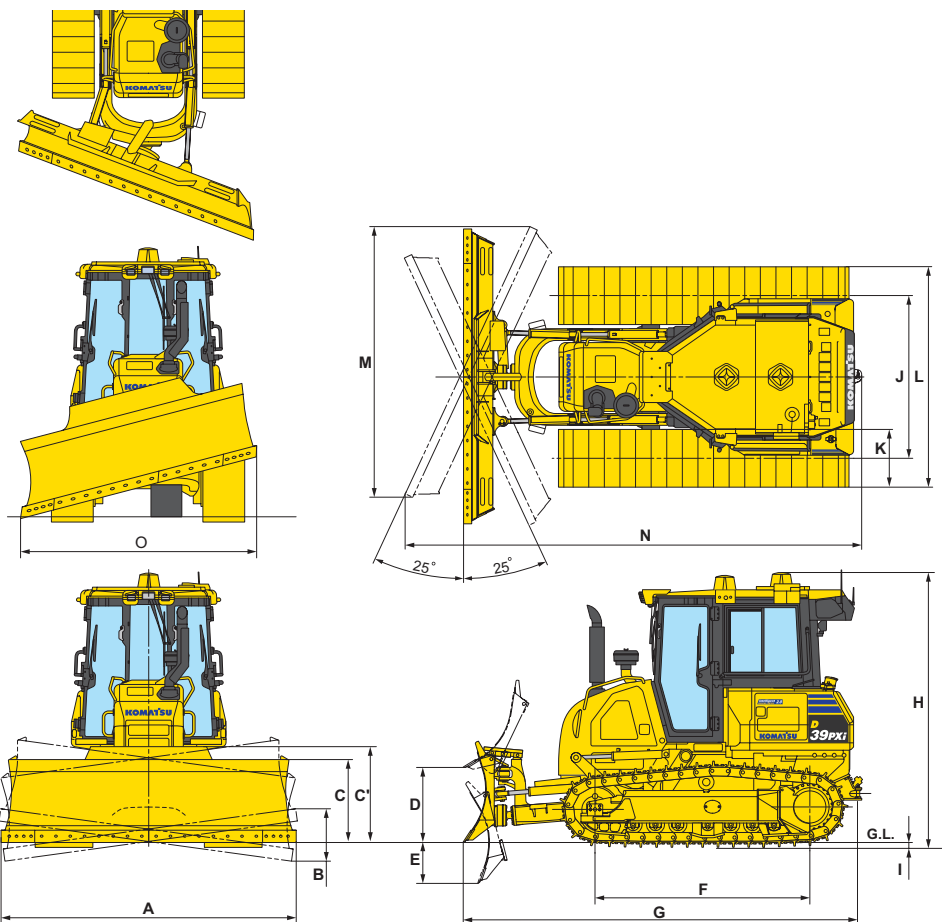

SPECIFICATIONS



HYDRAULIC SYSTEM

Closed-Center Load Sensing System (CLSS) designed for precise and responsive control, and for efficient simultaneous operation.

Hydraulic control unit:

All spool control valves externally mounted remote to the hydraulic tank. Piston-type hydraulic pump with capacity (discharge flow) of 99 ltr/min **26.2 U.S. gal/min** at rated engine rpm.

Relief valve setting 27.4 MPa 280 kg/cm² **3,974 psi**
Hydraulic cylinders..... Double-acting, piston type

	Number of cylinders	Bore
Blade lift	2	75 mm 3"
Blade tilt	1	90 mm 3.5"
Blade angle	2	80 mm 3.2"

Hydraulic oil capacity (refill):

Power angle tilt dozer 64 ltr **17 U.S. gal**

Control valves:

3-spool control valve for Power Angle Tilt dozer

Positions:

Blade lift Raise, hold, lower, and float

Blade tilt Right, hold, and left

Blade angle Right, hold, and left

Additional control valve required for ripper

Positions:

Ripper lift Raise, hold, and lower



DOZER EQUIPMENT

	Overall Length With Dozer* mm ft.in	Blade Capacity m ³ yd ³	Blade Width x Height mm ft.in	Max. Lift Above Ground mm ft.in	Max. Drop Below Ground mm ft.in	Max. Tilt Adjustment mm ft.in	Blade Angle
D39EXi-24	4385 mm	2.21 m ³	2710 mm x 980 mm	820 mm	440 mm	385 mm	25°
Standard Blade	14'5"	2.89 yd³	8'11" x 3'3"	2'8"	1'5"	1'3"	
D39PXi-24	4385 mm	2.40 m ³	3250 mm x 910 mm	820 mm	440 mm	440 mm	25°
Standard Blade	14'5"	3.14 yd³	10'8" x 3'	2'8"	1'5"	1'5"	
D39PXi-24	4385 mm	2.22 m ³	2980 mm x 910 mm	820 mm	440 mm	405 mm	25°
Narrow Blade	14'5"	2.90 yd³	9'9" x 3'	2'8"	1'5"	1'4"	

* Including hitch

Blade capacities are based on the ISO recommended practice 9246.

Use of high-tensile-strength steel in moldboard for strengthened blade construction.

D39EXi/PXi-24

EQUIPMENT



STANDARD EQUIPMENT FOR BASE MACHINE*

- Accumulator for Electric Proportional Control (EPC)
- Air cleaner, dry, double element type with caution lamp on monitor
- Air conditioner (A/C)
- Air inlet
- Alternator, 24 V/85 A
- Back-up alarm
- Batteries, large capacity 24 V/92 Ah
- Cab accessories
 - 12 V x 2 power supply
 - Cup holder
 - Rear view mirror
 - Rear view monitor system
 - Bluetooth/USB compatible radio with remote AUX plug (3.5 mm)
- Crankcase guard and underguard
- Decelerator/brake pedal (Single pedal)
- Electronically controlled Hydrostatic Transmission (HST) with quick-shift and variable speed settings
- Electronic monitor panel with on-board diagnostics
- Engine hood and side panels
- Engine, KOMATSU SAA4D95LE-7, gross output of 80 kW **107 HP**, direct injection, water-cooled turbocharged, air-to-air aftercooler, cooled EGR, EPA Tier 4 Final and EU Stage 4 emissions certified
- Fan, hydraulic driven, electronic control
- Filler cap locks and cover locks
- Foot rest, high mounted
- Fuel pre-filter (10 micron) and fuel filter (2 micron)
- Grease gun holder
- High altitude arrangement (No fuel adjustment up to 2300 m)
- Horn
- Hydraulics for PAT dozer
- Intake pipe with precleaner
- Large high-resolution LCD
- LED worklights
- Lunch box holder
- Marks and plates, English
- New Operator Identification System
- Palm Command Control System (PCCS) with electronic control for travel control
- Palm Command Control System (PCCS) with EPC for blade control
- Power turn with counter rotation
- Pullhook, front
- Radiator guard grid
- Radiator reserve tank
- Real-time DEF monitoring
- Rear-hinged radiator guard
- Reverse travel speed presets
- ROPS cab
 - Meets ISO 3471, SAE J/ISO 3471 ROPS standards, and ISO 3449 FOPS standard.
- Seat belt, 76 mm **3"** retractable
- Seat, air suspension, fabric, heated, low back, headrest
- Starting motor, 24 V/4.5 kW
- Self adjusting roller
- Sprockets, bolt-on
- Sprocket inner guard
- Track roller guards, end section
- Track shoe assembly (PLUS)
 - Heavy-Duty lubricated rotary bushing
 - D39EXi-24: 510 mm **20"** single grouser shoe
 - D39PXi-24: 635 mm **25"** single grouser shoe
- Triple labyrinth final drive
- Water separator

Dozer assembly and rear-mounted equipment are not included in base machine price.



OPTIONAL EQUIPMENT

- Dozer assembly
- Hitch
- Hydraulics for rear equipment
- Track roller guard, full length
- Multi-shank ripper (for D39EXi only)
 - Weight 470 kg **1,036 lb**
 - Beam length 1569 mm **62"**
 - Maximum lift above ground 389 mm **15"**
 - Maximum digging depth 336 mm **13"**
 - Number of shanks 3
- 700 mm **27.5"** single grouser (PX)(PLUS)



ALLIED MANUFACTURER'S ATTACHMENTS (SHIPPED LOOSE)

- Guarding - Komatsu (Ken Garner)
 - Front sweeps 229 kg **584 lb**
 - Hinged cab side screens 44 kg **97 lb**
 - Hinged cab rear screen 43 kg **95 lb**
 - Poly panel door inserts 41 kg **91 lb**
- Hydraulic winch - Allied H4AT 685 kg **1,510 lb**
- Fairlead, four roller
- Drawbar
- Arch, four roller





Note: All comparisons and claims of improved performance made herein are made with respect to the prior Komatsu model unless otherwise specifically stated.